

## FLASHINGS

made of galvanized, coated steel  
material thickness 0,75 mm; maximum length up to 6.000 mm

side A: 25 µm polyester coating with protective film

side B: RSL protective back coating

available in colours matching the panels cover sheets

production possible on the basis of profile drawings sent by customer or standard drawings from our flashings catalogue  
special designs on request

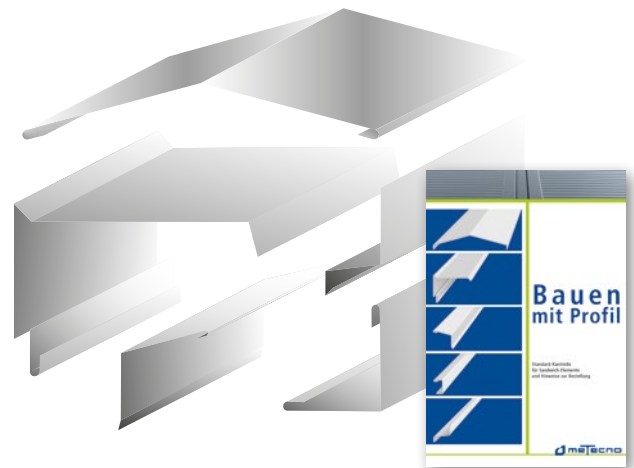

## DESIGN DETAILS

Our planning folder contains detailed application solutions in PDF-and DWG-format (available at [www.en.metecno.de](http://www.en.metecno.de)). It also contains text templates for quick preparation of tenders with our sandwich elements and flashings. The BIM objects for our sandwich panel product line are available for download at [www.bimobjects.com](http://www.bimobjects.com).

## G4® ROOF PANEL eaves detail

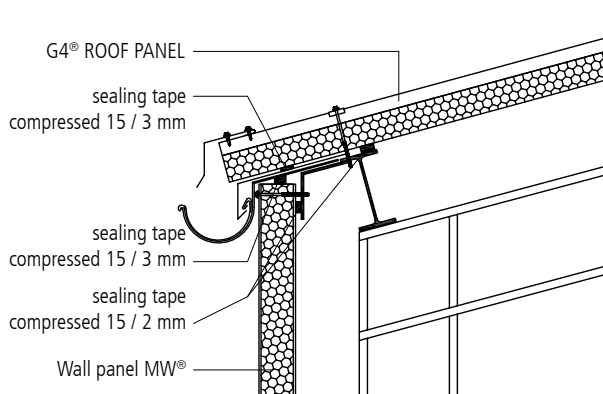

source: ATeO-Service

## PRESSING TOOL FOR SANDWICH WALL PANELS

In order to comply with the joint flow rate coefficient of  $\leq 0,1\text{m}^3/(\text{mh}/\text{daPa})$  required by DIN 18542, we recommend the use of pressing tools for the installation of sandwich wall panels in order to ensure the necessary compression of the sealing tapes in the longitudinal joint.

Item No. MET-ADV-WO1



**RIDGED COVER FLASHING FOR G4® AND HIPERTEC® ROOF**

Item No. ZB-A38, Z = 120 mm / L = 1000 mm



**RIDGED COVER FLASHING FOR H-WALL® 8 P**

Item No. ZB-H8, Z = 50 mm / L = 1000 mm



**FILLER BLOCKS FOR G4® AND HIPERTEC® ROOF**

Item No. DB-A38-01, W = 30 mm / L = 1000 mm

Item No. DB-A38-02 (self-adhesive)



**FILLER BLOCKS FOR H-WALL® 8 P**

Item No. DB-H8, W = 30 mm / L = 1000 mm

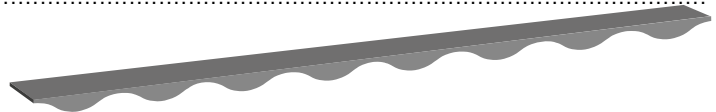

**SELF-ADHESIVE COMPRESSION TAPES**

Item No. SDB-E, size 10 / 2-4 mm (10 / 2-3 mm), 22 m/roll

Item No. SDB-E, size 14 / 2-4 mm (15 / 2-3 mm), 22 m/roll

Item No. SDB-E, size 14 / 2-6 mm (15 / 3-6 mm), 18 m/roll

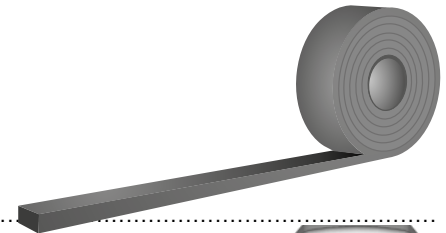

**SADDLE CAPS**

Item No. KL colour code -01, made of aluminium with vulcanized sealing

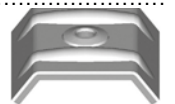

**Z-LOAD DISTRIBUTION PLATE [Z-SADDLE CAP] FOR SUPERWALL®, METFIBER ECO HF AND H-WALL® 8 P**

for hidden fixing with higher tensile forces

Item No. KL-V2A-04

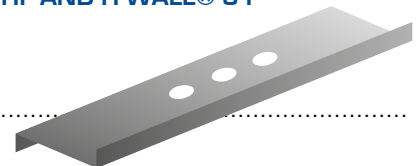

**CORRUGATED PROFILE G4 (38/333/1000)**

can be combined with sandwich panel

G4® and Hipertec® ROOF

e.g. canopies



Side A: 25 µm Polyester coating with protective film / Side B: RSL-protective lacquer

lengths: 1.500 mm to 15.000 mm (other lengths on request) / sheet thicknesses: 0,50 mm, 0,60 mm, 0,75 mm

**CORRUGATED PROFILE H8 (20/125/875)**

Same profile as panel H-Wall® 8 P

e.g. for cladding of solid walls

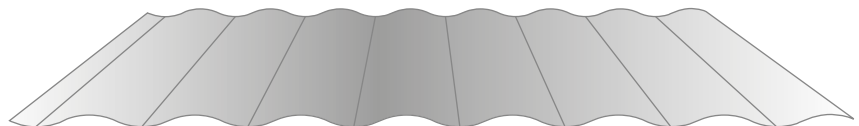

Side A: 25 µm Polyester coating with protective film / Side B: RSL-protective lacquer

lengths: 2.000 mm to 7.500 mm (other lengths on request) / sheet thicknesses: 0,75 mm